

Name

RELEASED FORM

Biology

Form I

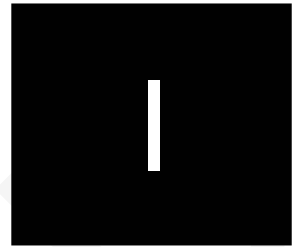

North Carolina Test of Biology

Public Schools of North Carolina
www.ncpublicschools.org
State Board of Education
Department of Public Instruction
Division of Accountability Services/North Carolina Testing Program
Raleigh, North Carolina 27699-6314



1. An iodine solution is placed on the cut side of a potato. Within seconds, a blue-black color appears. What is *most likely* occurring?
- A a positive test for proteins
 - B a positive test for starches
 - C a negative test for proteins
 - D a negative test for starches
2. A person with swollen gums rinses his mouth with warm salt water, and the swelling decreases. Which has occurred?
- A The swollen gums have absorbed the saltwater solution.
 - B The saltwater solution lowers the temperature of the water in the gums.
 - C The salt in the solution has moved against the concentration gradient.
 - D The water in the gums has moved from a high to a low concentration of water.

3. This diagram represents a cell.

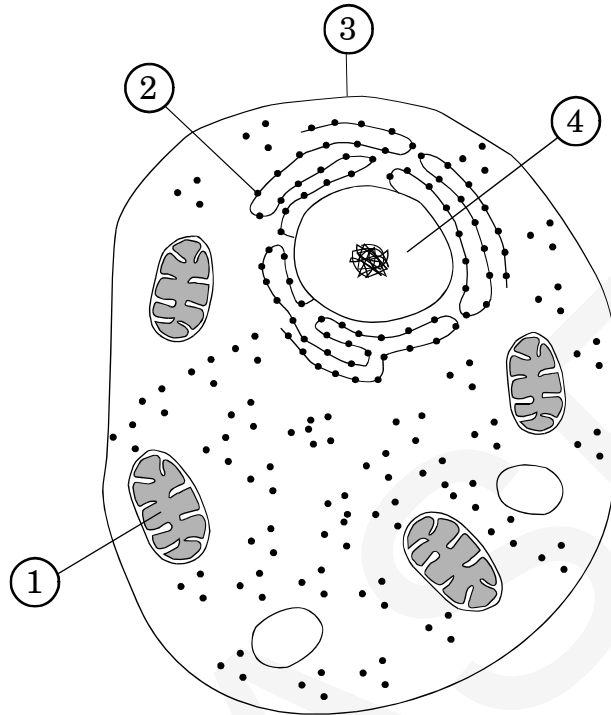

Which organelle is the site where amino acids are synthesized into proteins?

- A (1)
- B (2)
- C (3)
- D (4)

4. Which organism is ***most likely*** to use anaerobic respiration?
- A bird
 - B moss
 - C tree
 - D yeast

5. Plant cells that are specialized for cell division are ***most likely*** found in what part of a plant?
- A root tips
 - B leaf epidermis
 - C stem epidermis
 - D vascular tissue

6. This diagram represents the bone structures of the front limbs of four different animals.

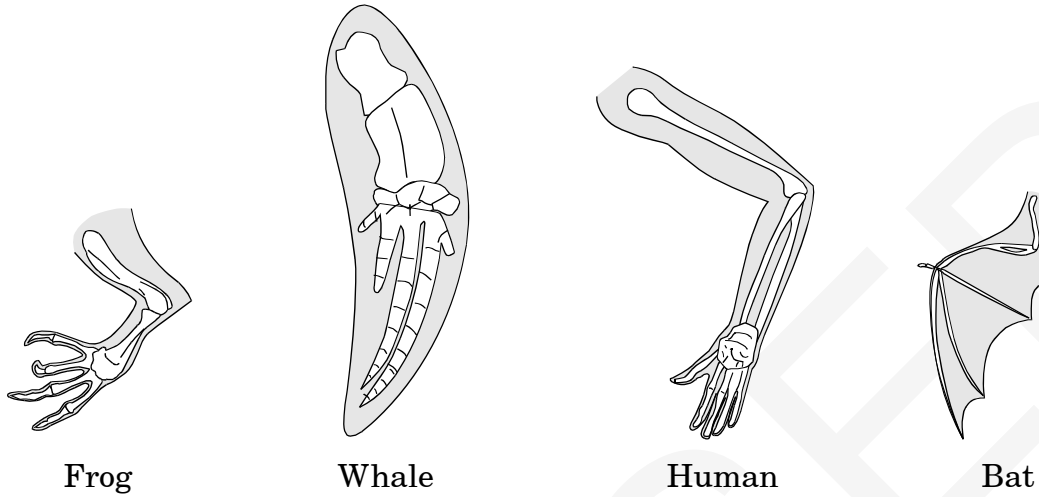

What do the similarities of the structures suggest about these organisms?

- A They grow at the same rate.
- B They live in the same environment.
- C They live for the same length of time.
- D They evolved from a common ancestor.

7. This chart represents amino acids that are coded from different combinations of mRNA codons.

Codons in mRNA

First Base	Second Base							Third Base	
	U		C		A		G		
	UUU	Phenylalanine	UCU	Serine	UAU	Tyrosine	UGU	Cysteine	U
U	UUC	Phenylalanine	UCC	Serine	UAC	Tyrosine	UGC	Cysteine	C
	UUA	Leucine	UCA	Serine	UAA	Stop	UGA	Stop	A
	UUG	Leucine	UCG	Serine	UAG	Stop	UGG	Tryptophan	G
	CUU	Leucine	CCU	Proline	CAU	Histidine	CGU	Arginine	U
C	CUC	Leucine	CCC	Proline	CAC	Histidine	CGC	Arginine	C
	CUA	Leucine	CCA	Proline	CAA	Glutamine	CGA	Arginine	A
	CUG	Leucine	CCG	Proline	CAG	Glutamine	CGG	Arginine	G
	AUU	Isoleucine	ACU	Threonine	AAU	Asparagine	AGU	Serine	U
A	AUC	Isoleucine	ACC	Threonine	AAC	Asparagine	AGC	Serine	C
	AUA	Isoleucine	ACA	Threonine	AAA	Lysine	AGA	Arginine	A
	AUG	Methionine or start	ACG	Threonine	AAG	Lysine	AGG	Arginine	G
	GUU	Valine	GCU	Alanine	GAU	Aspartic Acid	GGU	Glycine	U
G	GUC	Valine	GCC	Alanine	GAC	Aspartic Acid	GGC	Glycine	C
	GUA	Valine	GCA	Alanine	GAA	Glutamic Acid	GGA	Glycine	A
	GUG	Valine	GCG	Alanine	GAG	Glutamic Acid	GGG	Glycine	G

Which amino acid sequence can be coded from the DNA sequence CAG TAG CGA?

- A Valine – Isoleucine – Glycine
- B Valine – Aspartic Acid – Alanine
- C Valine – Isoleucine – Alanine
- D Valine – Phenylalanine – Alanine

8. Which set of parents can **most likely** produce a child with type O blood?
- A one parent with type AB blood, and the other parent with type A blood
 - B one parent with type AB blood, and the other parent with type O blood
 - C one parent with heterozygous type A blood, and the other parent with type O blood
 - D one parent with homozygous type A blood, and the other parent with homozygous type B blood

9. This diagram represents samples of DNA that were cut with a restriction enzyme during DNA fingerprinting in a crime lab.

Crime DNA	Suspects			
	1	2	3	4
	██████████			
██████████		██████████	██████████	
██████████	██████████	██████████		
			██████████	
██████████	██████████	██████████	██████████	██████████
				██████████
██████████		██████████	██████████	██████████
	██████████		██████████	

Which technique was used to produce these bands?

- A cloning
- B gel electrophoresis
- C gene splicing
- D genetic engineering

10. What process produces many variations in phenotypes?
- A independent assortment
 - B asexual reproduction
 - C regeneration
 - D cloning
11. One of the parents of a child has phenylketonuria (PKU), which is caused by recessive alleles. The other parent does not have the PKU alleles. What is the chance that the couple will have a child with phenylketonuria?
- A 0%
 - B 50%
 - C 75%
 - D 100%
12. Which disease *most likely* occurs after excessive exposure to ultraviolet radiation?
- A malaria
 - B asthma
 - C skin cancer
 - D polio
13. Why are humans important to the life cycle of malaria parasites?
- A Malaria parasites kill humans.
 - B Malaria parasites only live in human cells.
 - C Malaria parasites can live in mutual symbiosis with humans.
 - D Malaria parasites use humans for reproductive purposes.

14. This chart represents characteristics of four different plants.

Characteristics of Four Different Plants

	Vascular Tissue	Seeds	Flowers	Cones
Plant 1	X	X		X
Plant 2	X			
Plant 3				
Plant 4	X	X	X	

Which plant is *most likely* a gymnosperm?

- A Plant 1
- B Plant 2
- C Plant 3
- D Plant 4

15. In an experiment, Pavlov caused a dog to salivate when it heard the ring of a bell. Which type of learning was demonstrated by the dog?

- A habituation
- B imprinting
- C conditioning
- D trial and error

16. If the xylem in a young tree is damaged, which process is *first* affected?

- A performing photosynthesis
- B transporting sugar to the roots
- C transporting water to the leaves
- D absorbing water from the soil

17. A plant species lives in an area with limited sunlight. Which physical adaptation would be **most** useful to the plant?

- A colorful flowers
- B large leaves
- C deep roots
- D thin cuticle

18. This diagram shows a food web of a meadow.

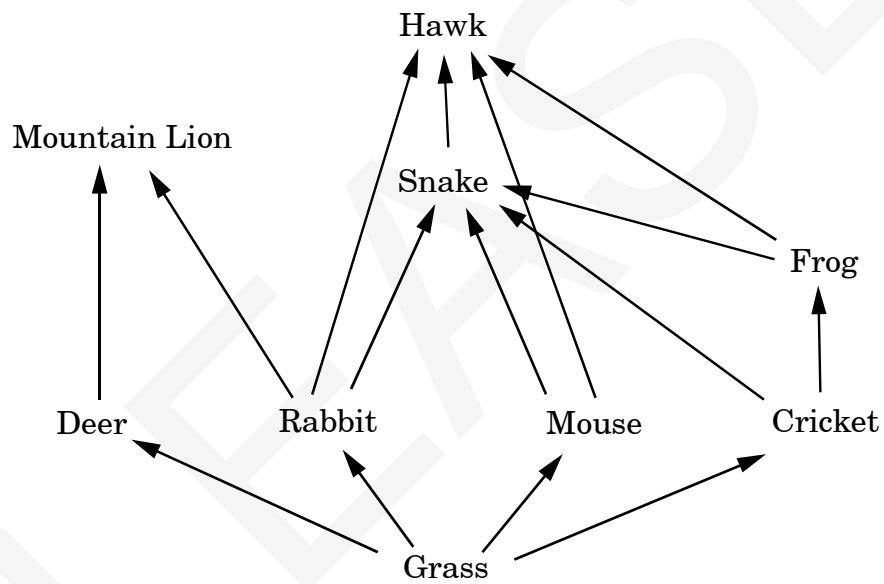

Due to insecticides, the cricket population is greatly reduced. Which population is **most** affected by this event?

- A Mouse
- B Hawk
- C Grass
- D Frog

19. The crab *Lybia tessellata* carries a pair of sea anemones on its claws. The crab uses the sea anemone's stinging tentacles as protection and the sea anemone obtains small food particles released by the crab as it feeds. Which type of symbiotic relationship does this **best** illustrate?
- A commensalism
 - B mutualism
 - C parasitism
 - D predation
20. Which substance is considered to be a factor affecting Earth's ozone layer?
- A chlorofluorocarbons
 - B ethyl alcohol
 - C nitrogen gas
 - D water vapor

21. RNA and DNA are which type of organic compound?
- A carbohydrate
 - B lipid
 - C nucleic acid
 - D protein
22. A scientist treats a cell with a chemical that destroys the ribosomes. As a result, which cell process will be stopped?
- A osmosis
 - B photosynthesis
 - C protein synthesis
 - D respiration
23. Which is an example of osmosis?
- A potassium ions moving in and out of an animal cell
 - B carbon dioxide moving into the leaf cells of a plant
 - C oxygen moving into the bloodstream from the lungs
 - D water moving into the root cells of a plant

24. This diagram shows an enzyme-substrate complex.

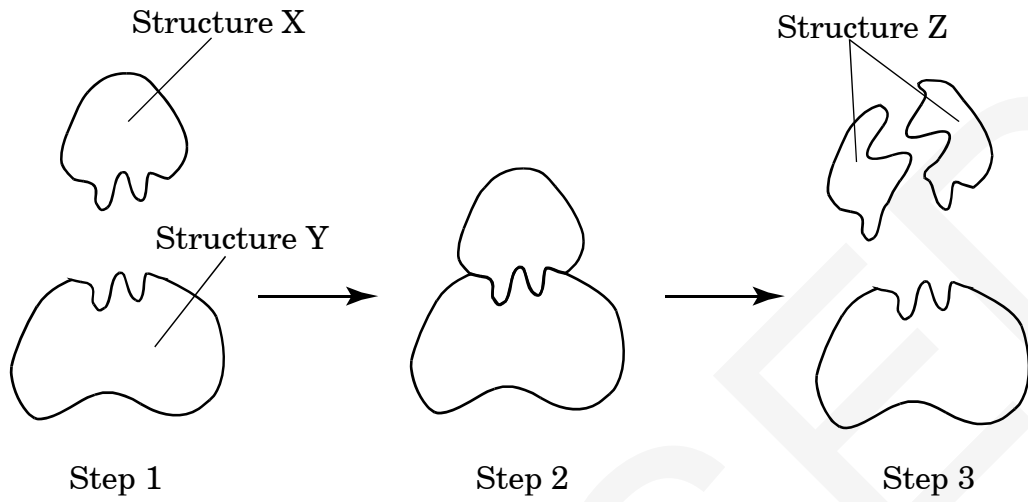

Which is represented by Structure X?

- A substrate
- B product
- C enzyme
- D complex

25. Two different species of bacteria are examined. Scientists find that Species X always produces CO_2 and H_2O during cellular respiration. Species Y always produces ethyl alcohol and CO_2 . Which conclusion can be made from these observations?
- A Only Species Y is aerobic.
 - B Only Species Y is anaerobic.
 - C Both Species X and Y are aerobic.
 - D Both Species X and Y are anaerobic.
26. Hitchhiker's thumb (H) is dominant to no hitchhiker's thumb (h). A woman who does not have hitchhiker's thumb marries a man who is heterozygous for hitchhiker's thumb. What is the probable genotypic ratio of their children?
- A 0% Hh : 100% hh
 - B 50% Hh : 50% hh
 - C 75% Hh : 25% hh
 - D 100% Hh : 0% hh
27. What advantage do sexually reproducing organisms have over asexually reproducing organisms?
- A genetic variation
 - B genetic stability
 - C increased fertilization rate
 - D increased reproductive rate

28. This chart shows a list of messenger RNA codons.

Codons in mRNA

First Base	Second Base								Third Base
	U		C		A		G		
	UUU	Phenylalanine	UCU	Serine	UAU	Tyrosine	UGU	Cysteine	U
U	UUC	Phenylalanine	UCC	Serine	UAC	Tyrosine	UGC	Cysteine	C
	UUA	Leucine	UCA	Serine	UAA	Stop	UGA	Stop	A
	UUG	Leucine	UCG	Serine	UAG	Stop	UGG	Tryptophan	G
	CUU	Leucine	CCU	Proline	CAU	Histidine	CGU	Arginine	U
C	CUC	Leucine	CCC	Proline	CAC	Histidine	CGC	Arginine	C
	CUA	Leucine	CCA	Proline	CAA	Glutamine	CGA	Arginine	A
	CUG	Leucine	CCG	Proline	CAG	Glutamine	CGG	Arginine	G
	AUU	Isoleucine	ACU	Threonine	AAU	Asparagine	AGU	Serine	U
A	AUC	Isoleucine	ACC	Threonine	AAC	Asparagine	AGC	Serine	C
	AUA	Isoleucine	ACA	Threonine	AAA	Lysine	AGA	Arginine	A
	AUG	Methionine or start	ACG	Threonine	AAG	Lysine	AGG	Arginine	G
	GUU	Valine	GCU	Alanine	GAU	Aspartic Acid	GGU	Glycine	U
G	GUC	Valine	GCC	Alanine	GAC	Aspartic Acid	GGC	Glycine	C
	GUA	Valine	GCA	Alanine	GAA	Glutamic Acid	GGA	Glycine	A
	GUG	Valine	GCG	Alanine	GAG	Glutamic Acid	GGG	Glycine	G

A strand of DNA with the sequence AAC AAG CCC undergoes a mutation, and the first A is changed to a C. How will this mutation affect the amino acid sequence?

- A One amino acid will change.
- B Two amino acids will change.
- C All of the amino acids will change.
- D The amino acids will remain the same.

29. Which is a use of genetically engineered bacteria?
- A identifying the remains of an unknown person
 - B developing a DNA fingerprint for blood left at a crime scene
 - C making human insulin for diabetics
 - D producing corn that is resistant to herbicides
30. Which types of organisms developed first due to the early environmental conditions on Earth?
- A prokaryotic and aerobic
 - B prokaryotic and anaerobic
 - C eukaryotic and aerobic
 - D eukaryotic and anaerobic

31. This diagram shows a pedigree for a recessive genetic disorder.

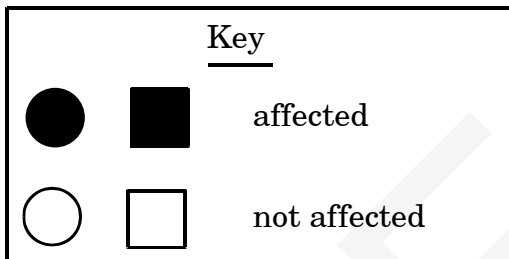
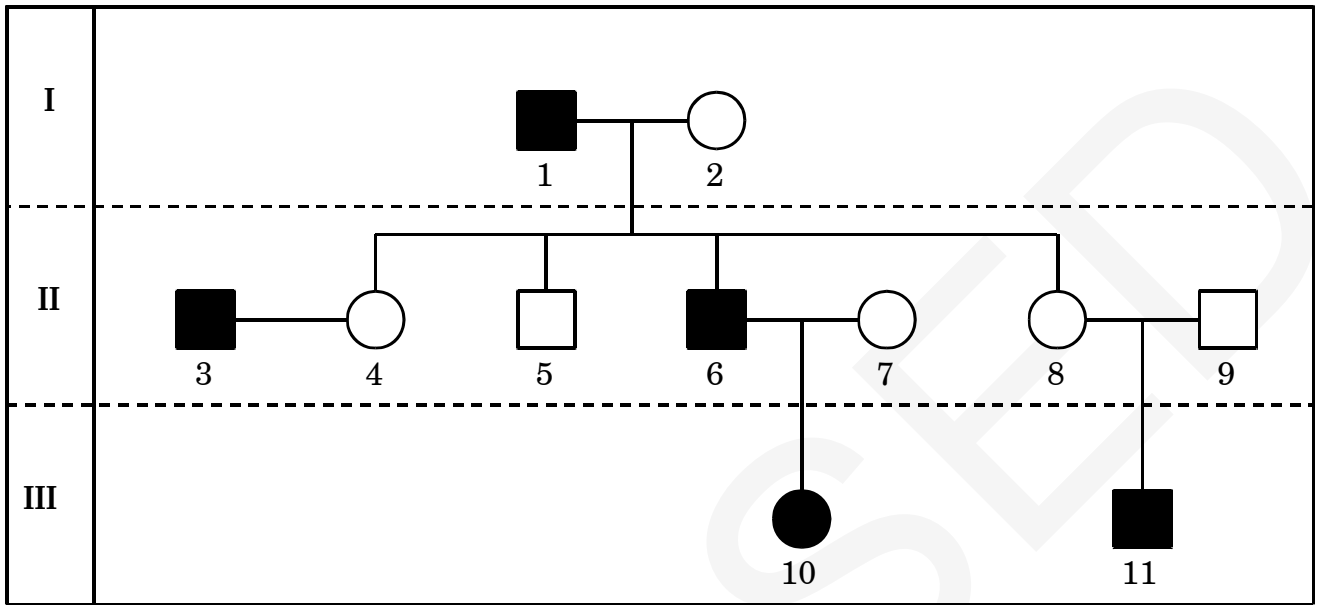

What is the genotype of individual 6?

- A $X^H X^H$
- B $X^H X^h$
- C $X^H Y$
- D $X^h Y$

32. Which is an example of a learned behavior?
- A A bear cub practices catching salmon the way its mother does.
 - B A baby gazelle rises to its feet within a few minutes of its birth.
 - C A baby kangaroo climbs into its mother's pouch as soon as it is born.
 - D An adult salmon returns to its freshwater stream when it is time to reproduce.
33. Sandworms are annelid worms that live on the seafloor. They absorb oxygen and excrete wastes through their skin. Which characteristic will **best** help the worm carry out these functions?
- A large number of hearts
 - B large diameter blood vessels
 - C large mouth compared to body volume
 - D large surface area compared to body volume
34. Which reproductive adaptation is more characteristic of mammals than amphibians?
- A external fertilization with internal development
 - B internal fertilization with internal development
 - C external fertilization with external development
 - D internal fertilization with external development
35. What kingdoms did Carolus Linnaeus originally use for his classification system?
- A Fungi and Protista
 - B Fungi and Animalia
 - C Plantae and Protista
 - D Plantae and Animalia

36. After an initial infection, B-cells recognize the measles virus. How is this helpful in human immune response?
- A The B-cells use this recognition to defend the body against other pathogens, such as bacteria.
 - B The B-cells more quickly recognize and respond to any other virus that invades the body.
 - C The B-cells produce antibodies more quickly if the measles virus is encountered again.
 - D The B-cells transfer this recognition to T-cells, which will then devour the viruses.
37. What is the main function of leaves?
- A Leaves provide support for growth and a place to store food.
 - B Leaves provide a place for photosynthesis to occur.
 - C Leaves absorb water and minerals and transport nutrients to the stem.
 - D Leaves create a barrier that prevents water in the plant's tissues from evaporating.
38. In an ecosystem, which is the *most likely* reason for an increase in the producer population if there is an increase in the carnivore population?
- A fewer herbivores
 - B higher temperatures
 - C less food
 - D more oxygen

